

# STEEL BEAST®

**JEI**  
Solutions  
Built for Industry

# PB2

## COMPACT PIPE BEVELLER



**Max wall thickness  
up to 8 mm (0.32")**

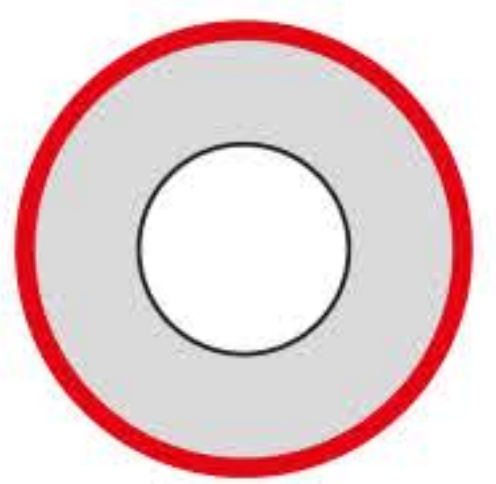

**Pipe OD beveling  
up to 48 mm (1.89")  
up to 60.3 mm (2.37") /option/**

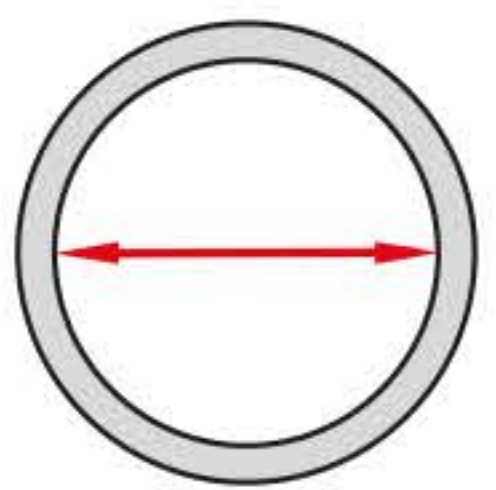

**ID 22-42 mm (0.87-1.65")  
15.5-22 mm (0.61-0.87") /option/  
42-58 mm (1.65-2.28") /option/**



**Facing off**

PB2 is a compact, handy pipe beveler that mills pipes made of carbon and stainless steel, aluminum alloys, and copper-nickels. The machine can face and bevel pipes from inner diameters (ID) of 22 mm (0.87") to outer diameters (OD) of 48 mm (1.89").

Small pipes from ID 15.5 mm (0.61") up to OD 30 mm (1.18") can be beveled with optional small mandrel set.

PB2 is able to mill also larger pipes from ID 42 mm (1.65") up to OD 60.3 mm (2.37") by means of an optional extension set.

Its exceptionally narrow housing (only 48 mm wide) makes it perfectly suited to space restricted areas such as boiler water walls.

PRO-2 PB incorporates overload systems incl. wet multi-disk friction clutch to prevent gear damage if the tool gets stuck.

CALL 01706 229 490 TO BOOK YOUR DEMONSTRATION NOW OR VISIT [WWW.STEELBEAST.CO.UK](http://WWW.STEELBEAST.CO.UK)

[WWW.JEIUK.COM](http://WWW.JEIUK.COM)

PART NUMBER: PB2

JEI Solutions



## BATTERY DRIVE



## ELECTRIC MOTOR



## PNEUMATIC MOTOR



TECHNICAL SPECIFICATION	PB2-A	PB2-E	PB2-B
Air requirement	0.6 MPa (87 psi)	-	-
Air consumption	1400 l/min (50 CFM)	-	-
Voltage	-	1 ~ 220-240 V, 50-60 Hz	18 V DC, 5.2 Ah
Power	800 W	1100 W	-
Connection	CEJN 410 DN 10.4 R 1/2" BSPT fitting for quick-coupling	Electrical plug	Battery connection
Nominal rotational speed	105 rpm	10-134 rpm (gear 1) 30-377 rpm (gear 2)	10-60 rpm (gear 1) 30-205 rpm (gear 2)
Pipe diameter	22 mm ID – 48 mm OD 15.5 mm ID – 30 mm OD* 42 mm ID – 60.3 mm OD**	22 mm ID – 48 mm OD 15.5 mm ID – 30 mm OD* 42 mm ID – 60.3 mm OD**	22 mm ID – 48 mm OD 15.5 mm ID – 30 mm OD* 42 mm ID – 60.3 mm OD**
Maximum pipe wall thickness	8 mm 3.5 mm*	8 mm 3.5 mm*	8 mm 3.5 mm*
Weight with motor	7.6 kg (17 lbs)	7.4 kg (16.5 lbs)	6.5 kg (14.5 lbs), includes battery

\*With an optional small mandrel set (PB2-SMS).

\*\* With an optional extension set (PB2-ES).

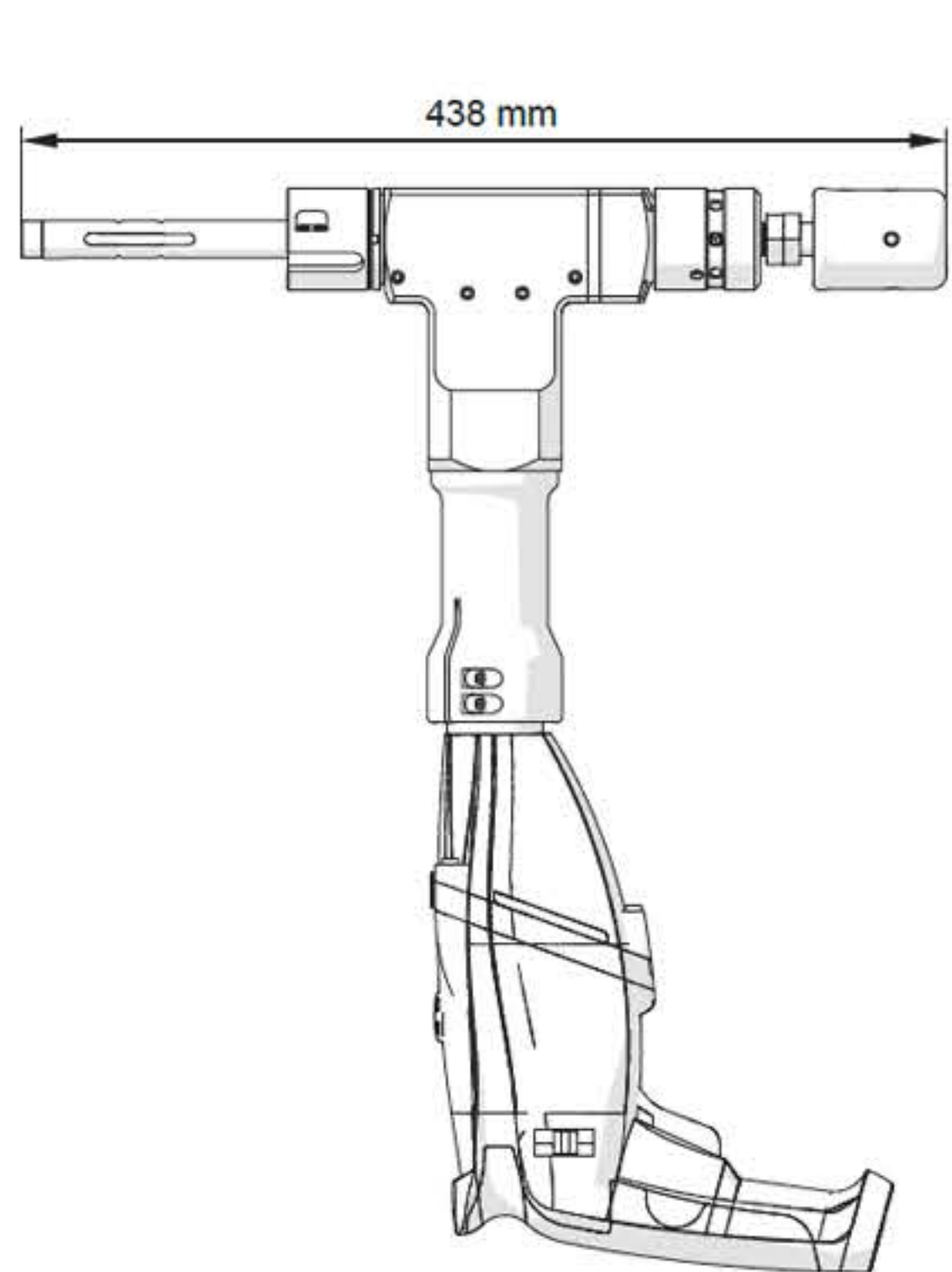

PB2 with electric motor

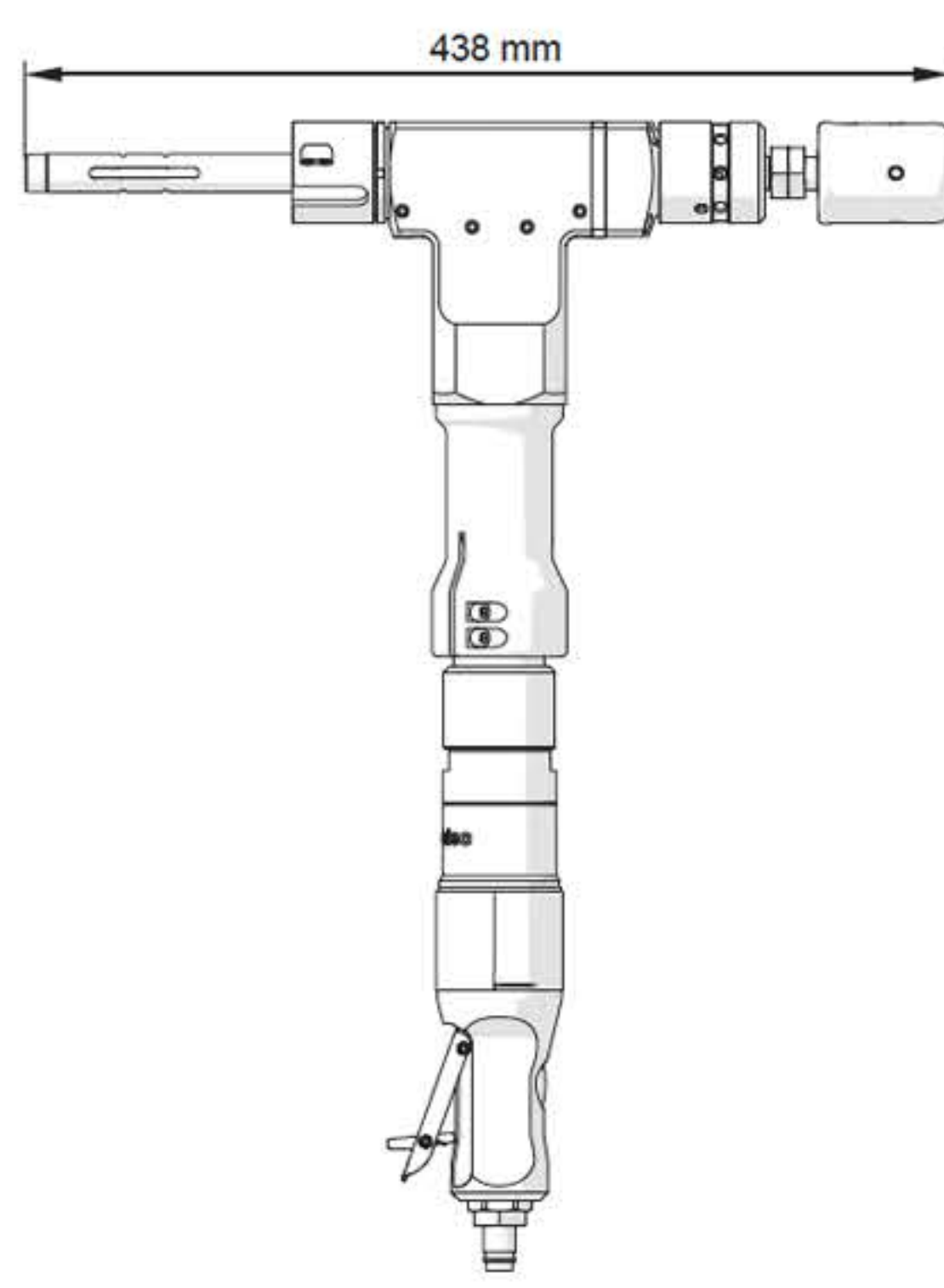
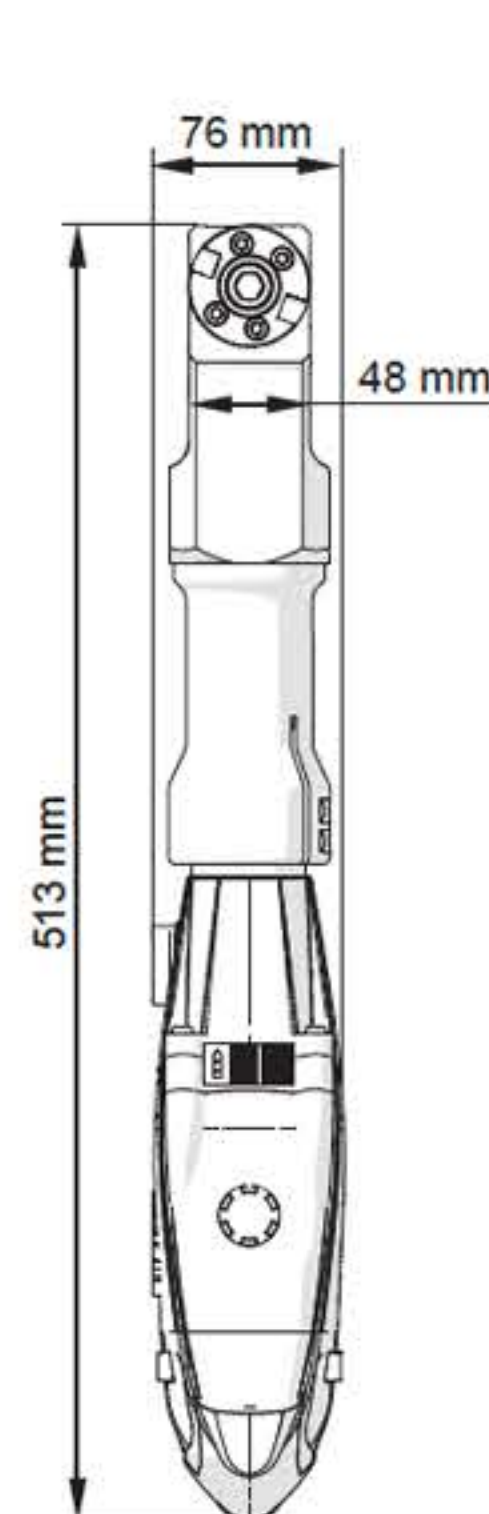

PB2 with pneumatic motor

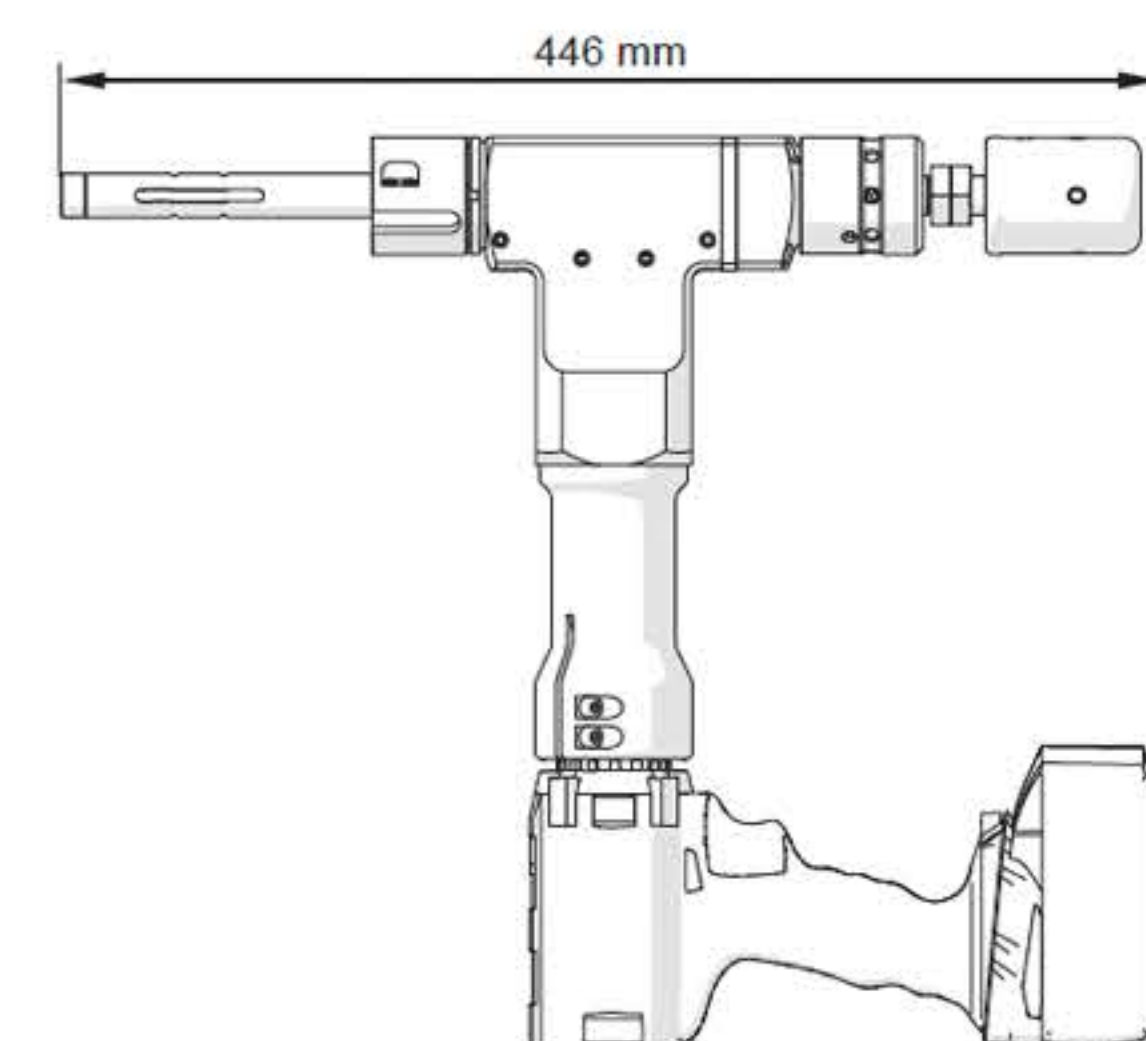
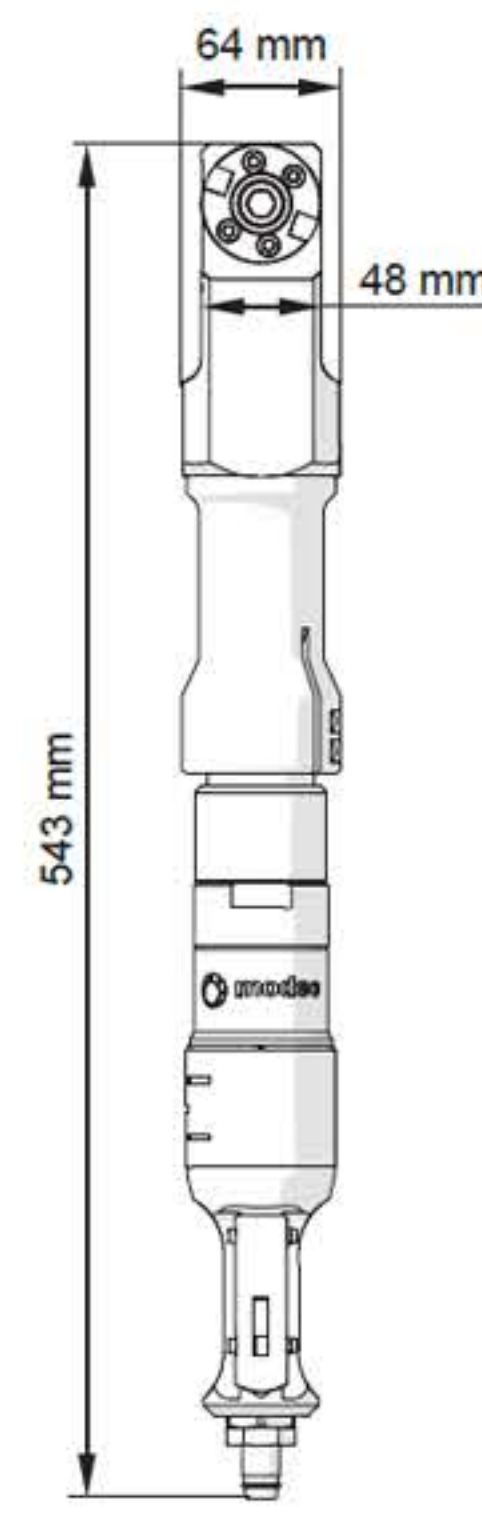

PB2 with battery motor

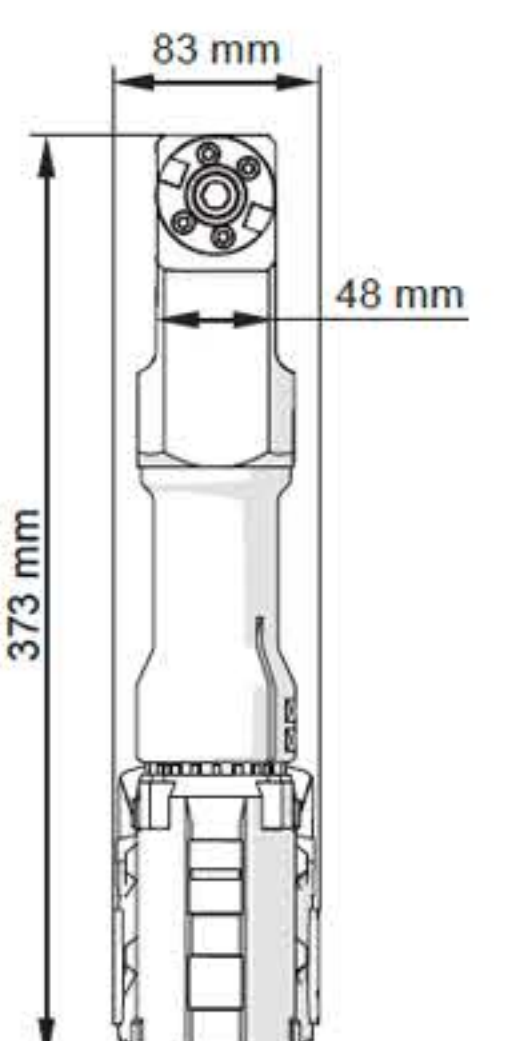

## STANDARD SHIPPING SET

- ✓ Beveling machine (without motor, tool bits)
- ✓ Metal box
- ✓ Standard self-centering expandable mandrel for pipe ID Ø 22-42 mm (0.87-1.65")
- ✓ 2 sets of jaws (NO. 4, 5), 3 sets of jaw blocks (no. 6, 7, 8) and 5 sets of springs (no. 4, 5, 6, 7, 8) for standard mandrel
- ✓ Tool bit holder
- ✓ Spring gauge
- ✓ Handle
- ✓ Coolant container with nozzle
- ✓ Set of tools
- ✓ Operator's manual 513

CALL 01706 229 490 TO BOOK YOUR DEMONSTRATION NOW OR VISIT [WWW.STEELBEAST.CO.UK](http://WWW.STEELBEAST.CO.UK)

Pneumatic motor  
Product Code: PB2-PM



Adapter and driver  
Product Code: PB2-AC

Driver  
Product Codes:  
PB2-E/1-110  
PB2-E/2-220

Electric motor  
Product Code: PB2-EM



Battery motor and two 5.2 Ah batteries  
Product Code: PB2-B



Driver  
Product Code: PB2-B/C



5.2 Ah battery  
Product Code: AKM-000088



Battery charger  
Product Code:LDV-000008 (230 V CEE)  
LDV-000010 (120 V UK)  
LDV-000011 (230 V AU)



Air preparation set  
Product Code: PB2-APS

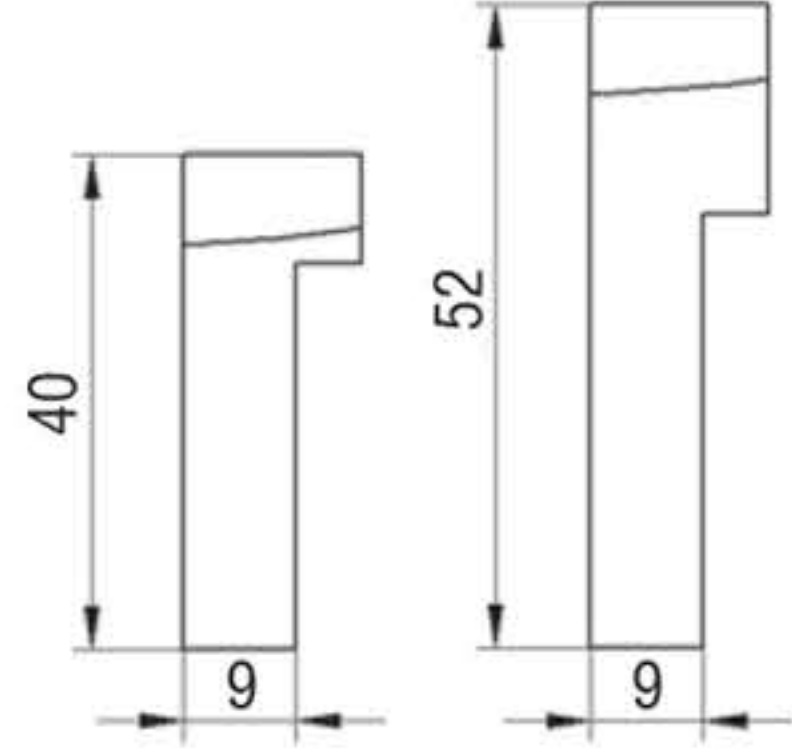
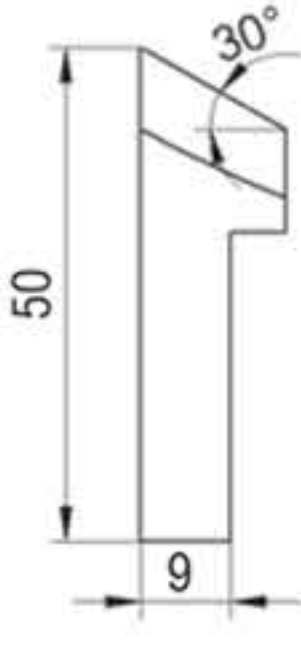
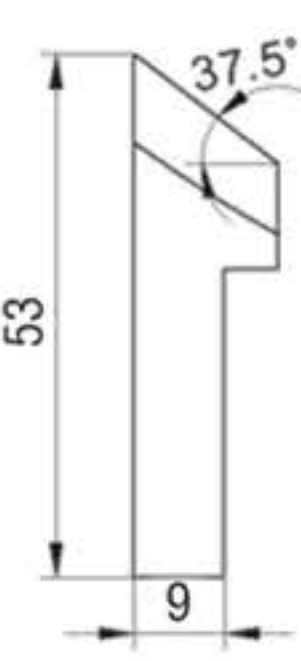
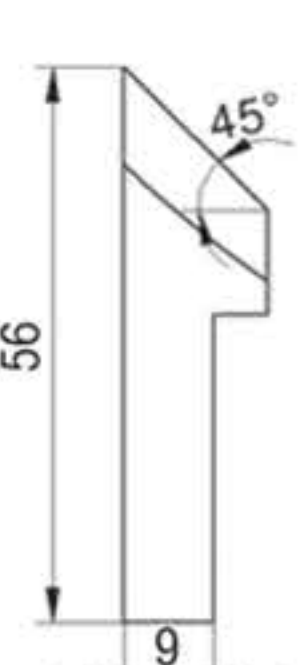

CALL 01706 229 490 TO BOOK YOUR DEMONSTRATION NOW OR VISIT [WWW.STEELBEAST.CO.UK](http://WWW.STEELBEAST.CO.UK)

NOZ-000071 for steel	0° facing tool bit short PB2-F040	
NOZ-000078 for stainless steel	0° facing tool bit short* PB2-F040155	
NOZ-000072 for steel	0° facing tool bit long PB2-F052	
NOZ-000079 for stainless steel	0° facing tool bit long* PB2-F052/55	
NOZ-000073 for steel	30° beveling tool bit PB2-B30	
NOZ-000080 for stainless steel	30° beveling tool bit* PB2-B30/55	
NOZ-000074 for steel	37.5° beveling tool bit PB2-B375	
NOZ-000081 for stainless steel	37.5° beveling tool bit* PB2-B375/55	
NOZ-000075 for steel	45° beveling tool bit PB2-B45	
NOZ-000082 for stainless steel	45° beveling tool bit* PB2-B45/55	

Small mandrel set for pipes  
from ID 15.5 mm (0.61") up to OD 30 mm (1.18")  
Product Code: PB2-SMS

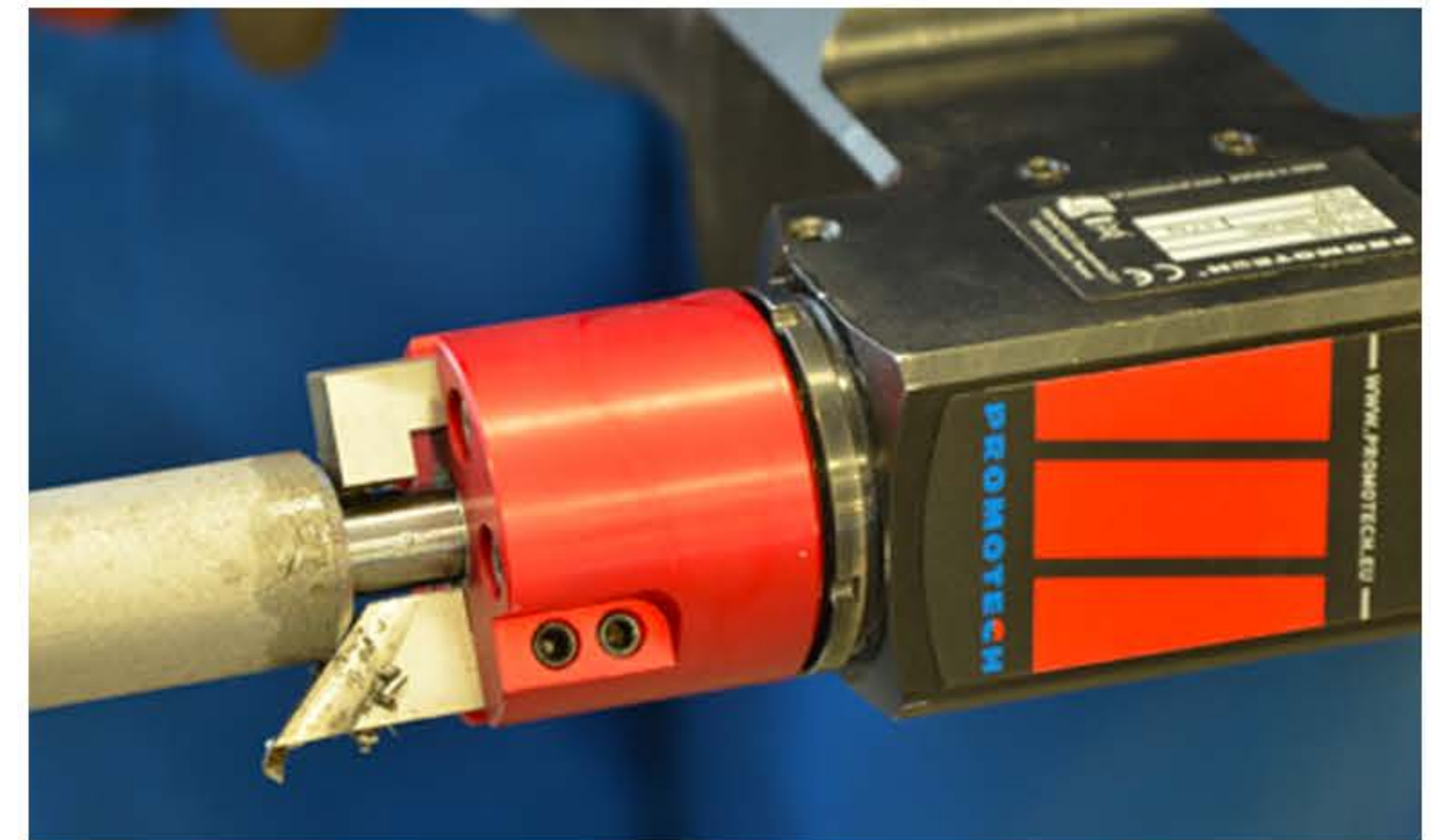

Extension set for pipes from ID 42 mm (1.65")  
up to OD 60.3 mm (2.37")  
Product Code: PB2-ES

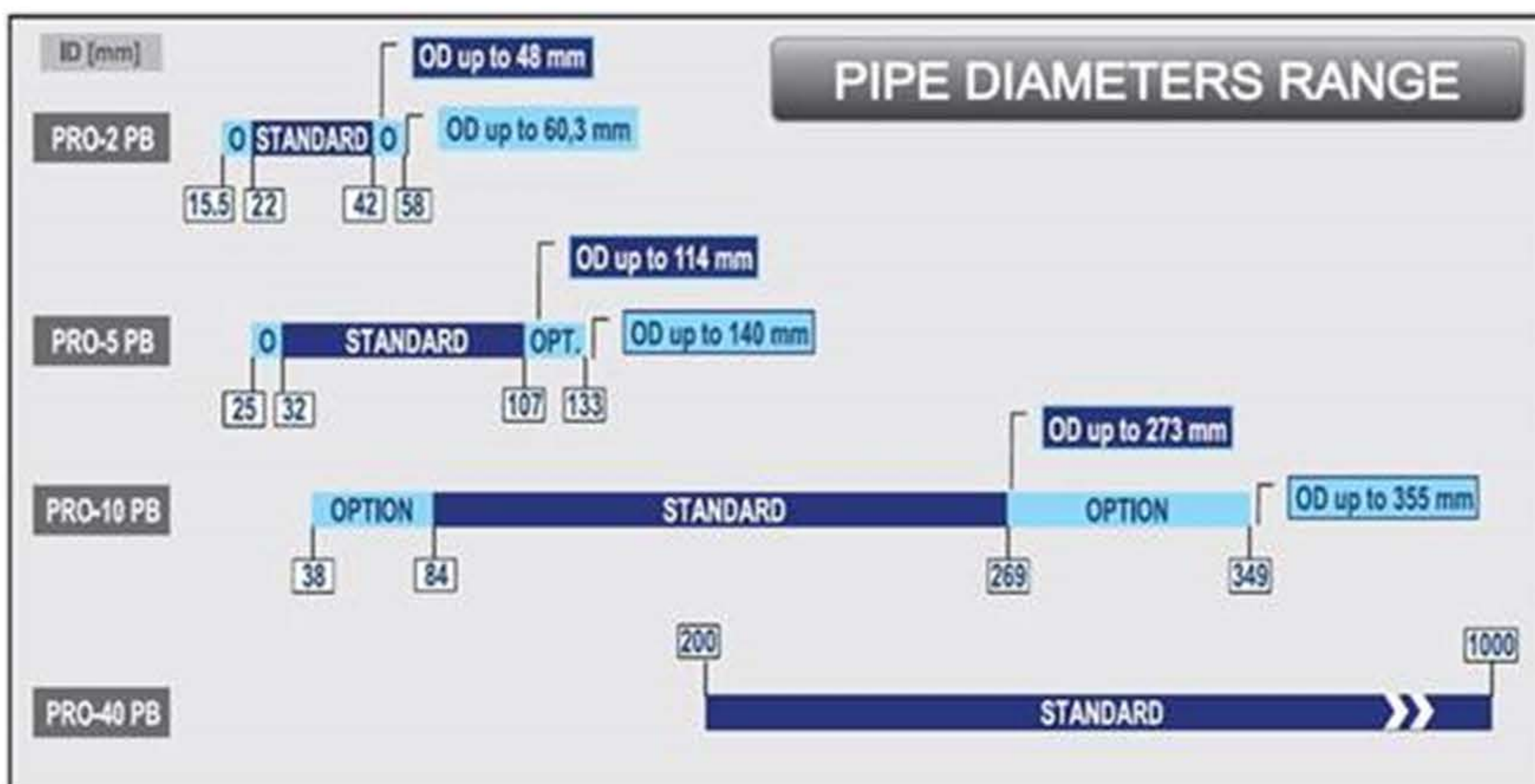
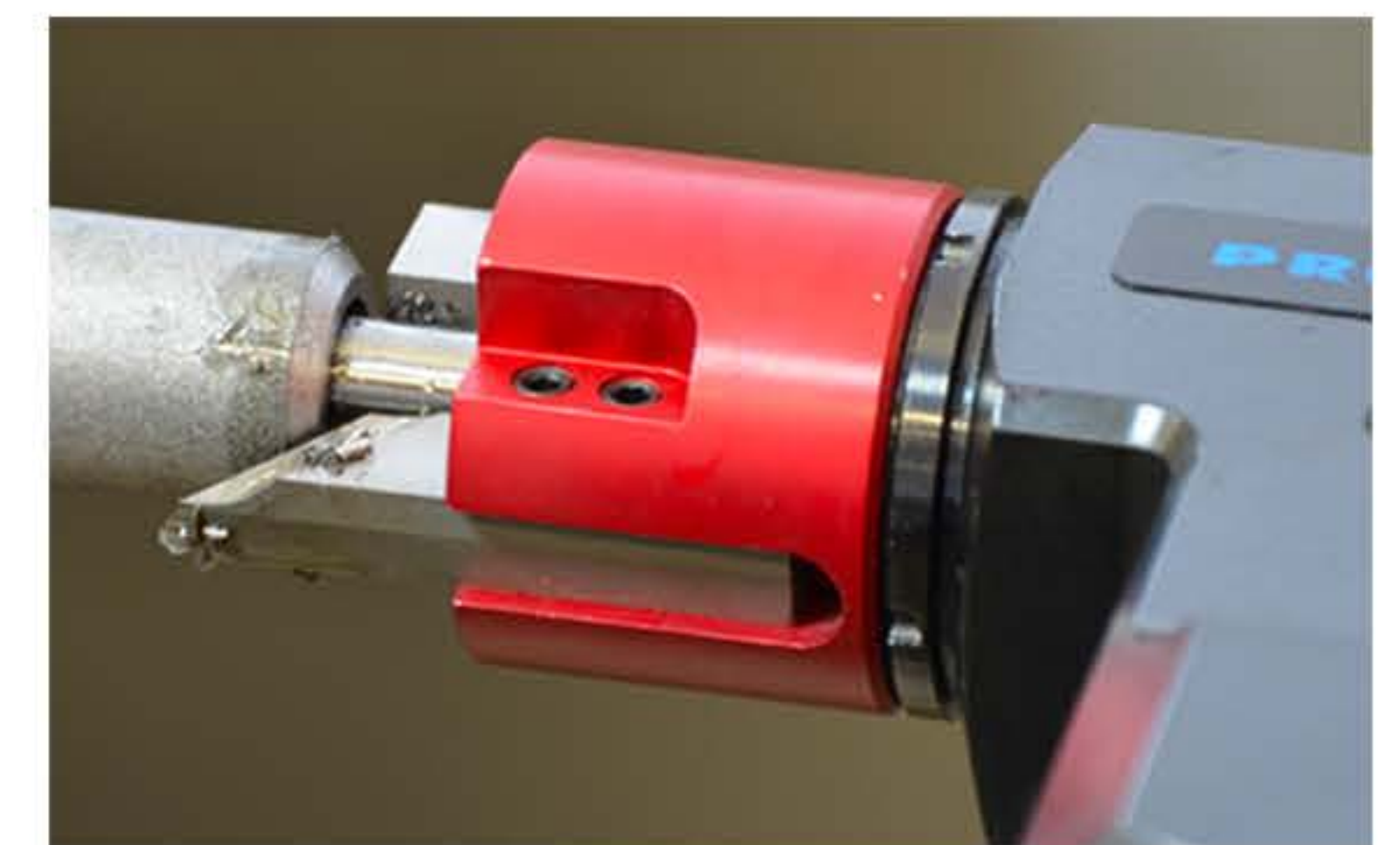
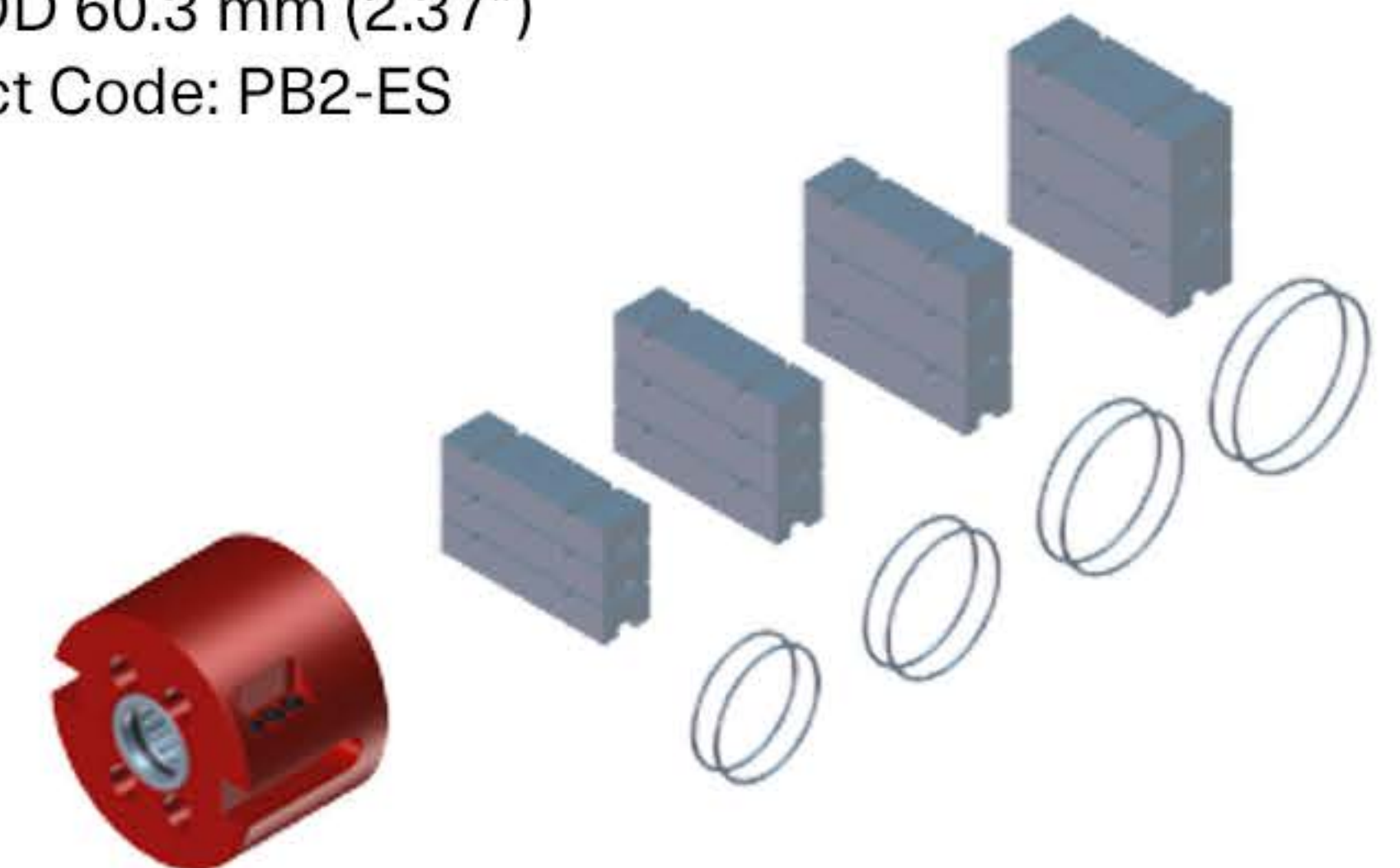

CALL 01706 229 490 TO BOOK YOUR DEMONSTRATION NOW OR VISIT [WWW.STEELBEAST.CO.UK](http://WWW.STEELBEAST.CO.UK)